

BEKO

BEKO

*installation, operation &
food storage instructions* **frost free combi
fridge freezer**

**Model
CDA751F
10.4 cu.ft.**

**CDA752F
10.1 cu.ft.**



BEKO BEKO

get the best from your new refrigerator

BEKO plc
Beko House
Caxton Way
Watford
Hertfordshire
WD18 8UF
Tel: 01923 654650
Fax: 01923 819653
e-mail: service@beko.co.uk
website: www.beko.co.uk

Printed in Turkey

Part no: 48 3335 00 00
Revision no: 0

first of all !

Congratulations on your choice of a Beko quality Combi fridge/freezer, which has been designed to give you service for many years.

Important

- Do not connect your appliance to the electricity supply until all packing and transit protectors have been removed.
- Leave to stand for at least 4 hours before switching on to allow the system to settle if transported horizontally.
- This appliance must only be used for its intended purpose, ie the storing and freezing of edible foodstuff.
- We do not recommend use of this appliance in an unheated, cold room e.g. garage, conservatory, annex, shed, out-house, etc., see 'Location' on page 6.
- To obtain the best possible performance and trouble free operation from your appliance, it is very important to carefully read these instructions.
- On delivery, check to make sure that the product is not damaged and that all the parts and accessories are in perfect condition.
- We do not recommend the use of extension leads and multi-way adapters.
- Failure to observe these instructions may invalidate your right to free service during the guarantee period. BEKO plc declines to accept any liability should the instructions not be followed.
- Do not dispose of the appliance on a fire. At BEKO, the care and protection of our environment is an ongoing commitment. This appliance which is among the latest range introduced is particularly environmentally friendly. Your appliance contains non CFC / HFC natural substances in the cooling system (Called R600a) and in the insulation (Called cyclopentane) which are potentially flammable if exposed to fire. Therefore, take care not to damage the cooling circuit / pipes of the appliance in transportation and in use. In case of a damage do not expose the appliance to fire, potential ignition source and immediately ventilate the room where the appliance is situated.
- We suggest you contact your local authority for disposal information and facilities available.
- **WARNING-** Keep ventilation openings, in the appliance enclosure or in the built-in structure, clear of obstruction.
- **WARNING-** Do not use mechanical devices or other means to accelerate the defrosting process, other than those recommended by the manufacturer.
- **WARNING-** Do not damage the refrigerant circuit.
- **WARNING-** Do not use electrical appliances inside the food storage compartments of the appliance, unless they are of the type recommended by the manufacturer.
- We suggest you keep these instructions in a safe place for easy reference.

specification

Performance	Model CDA 751F	Model CDA752F
Energy efficiency class	A	A
Energy consumption Kwh/year	395	391
Net storage volumes:		
fresh food litres (cu.ft.)	230 (8.1)	222 (7.8)
frozen food litres (cu.ft.)	118 (4.2)	118 (4.2)
Total gross litres (cu.ft.)	410 (14.5)	399 (14.0)
Frozen food compartment rating	4 star	4 star
Conservation time from failure (hrs)	18	18
Freezing capacity kg (lbs)	6	6
Climate class	SN	SN
Operating noise level dB(A)	41	41
Operating temperature range	+5 to +32 degrees C	+5 to +32 degrees C

Because we continually strive to improve our products, we may change our specifications and designs without prior notice.

Electrical

Transportation

Location

Installation

Switching on for the first time

Temperature control & adjustment

Repositioning the doors

Short term storage in the fridge compartment

Long term storage in the freezer compartment

CDA751F (Model without water dispenser)

How to use the accessories

Defrosting

Energy saving tips

Care & cleaning

Stainless steel door cleaning instructions

Internal light

Trouble shooting

Disposal

Guarantee

Service under guarantee

Service out of guarantee

Electrical requirements

Before you insert the plug into the wall socket make sure that the voltage and the frequency shown in the rating label, which is on the left hand side of the fridge inner liner corresponds to your electricity supply.

We recommend that this appliance be connected to the mains supply via a suitable switched and fused socket. The appliance must be positioned so that the plug is accessible.

Should the mains lead of the appliance become damaged or need replacing at any time, it must be replaced by a special purpose made mains lead which can only be obtained from a Beko Authorized Service Agent.

Warning

This appliance must be earthed

If the fitted moulded plug is not suitable for your socket, then the plug should be cut off and an appropriate plug fitted.

Destroy the old plug, which is cut off as a plug with a bared cord could cause a shock hazard if inserted into a socket elsewhere in the house.

The moulded plug on this appliance incorporates a 13A fuse. Should the fuse need to be replaced an ASTABEAB approved BS1362 fuse of the same rating must be used. Do not forget to refit the fuse cover. In the event of losing the fuse cover, the plug must not be used until a replacement fuse cover has been fitted. Colour of the replacement fuse cover must be the same colour as that visible on the pin face of the plug. Fuse covers are available from any good electrical store.

Important

Fitting a different plug

As the colours of the wires in the mains lead of this appliance may not correspond with the coloured markings identifying the terminals on your plug, proceed as follows:

- 1** Connect the green - yellow or green (earth) wire to the terminal in the plug marked 'E' or with the symbol  or coloured green and yellow or green.
- 2** Connect the blue (neutral) wire to the terminal in the plug marked 'N' or coloured black.
- 3** Connect the brown (live) wire to the terminal in the plug marked 'L' or coloured red.

With the alternative plugs a 13A fuse must be fitted either in the plug or adaptor or in the main fuse box. If in doubt contact a qualified electrician.

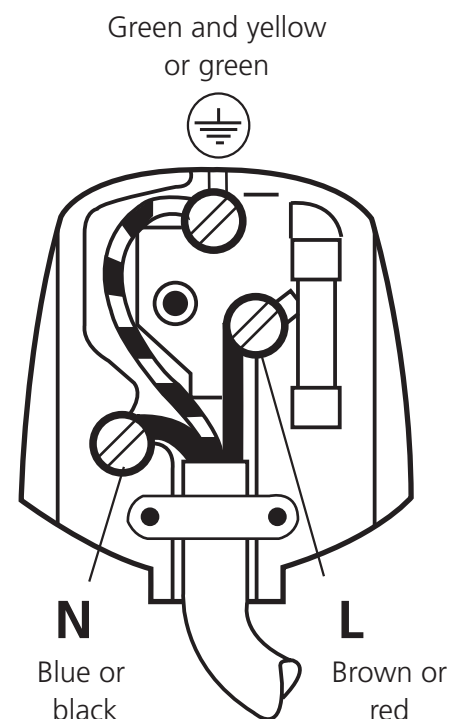

- The appliance should be transported only in a vertical upright position. The packing as supplied must be intact during transportation.
- If during the course of transport the appliance has to be transported horizontally, the product must only be laid on its right hand side (when facing the door front) and it must not be operated for at least 4 hours to allow the system to settle after the appliance is brought back to upright position.
- Failure to comply with the instructions could result in damage occurring to the appliance. The manufacturer will not be held responsible if these instructions are disregarded.
- The appliance must be protected against rain, moisture and other atmospheric influences.
- When positioning your appliance take care not to damage your flooring, pipes, wall coverings etc. Do not move the appliance by pulling by the door or handle.
- Empty any water in the drain tray and Water Dispenser tank before moving. See section 'Defrosting' and 'Care & cleaning' for further information.
- Make sure that the defrost water pipe at the back of the product is fixed to the plastic evaporating pan on the top of the compressor, to avoid defrost water spillage on the floor.
Important Care must be taken when carrying the appliance to avoid touching the bottom of the condenser metal support/pipework at the back of the appliance as you might injure your fingers and hands or damage your product.
- **Important** Make sure that mains cable is not caught under the appliance during and after carrying/moving the appliance, to avoid the mains cable becoming cut or damaged.
- Do not attempt to sit or stand on top of your appliance. You could injure yourself and damage the appliance.
BEKO plc declines to accept any liability should the instructions not be followed.

location

- Do not put your appliance in a cold room where the temperature is likely to go below +5 degrees C (41 degrees F) during night time and/or especially in winter.
- This appliance has been designed to operate in room (ambient) temperatures between +5 and +32 degrees C (41 and 90 degrees F). Therefore if it is installed in an unheated/cold room (eg conservatory, annex, shed, garage, etc.) then it will not operate causing the freezer compartment to run warmer and as a result the storage time of frozen food may be reduced.
- Do not place the appliance near cookers, radiators, or in direct sunlight as this will cause it to work harder. If installed next to a source of heat, maintain the following minimum side clearances:

From cookers	50mm (2")
From radiators	300mm (12")
- Make sure that sufficient room is provided at the back of the appliance to ensure free air circulation. We also recommend 20mm ($\frac{4}{5}$ ") clearance on both sides, even though it is not essential for the operation of appliance. The essential clearance at the back is ensured when the wall spacers are fitted, see 'Installation'.

1 Fit the two plastic wall spacers supplied with the appliance, rotating $\frac{1}{4}$ turn to the condenser at the back of the appliance.

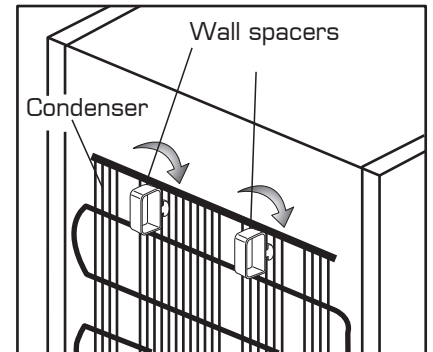

3 To ensure it is standing upright adjust the two front feet by turning clockwise or anti-clockwise, until it is in firm contact with the floor. Correct adjustment of feet avoids excessive vibration and noise.

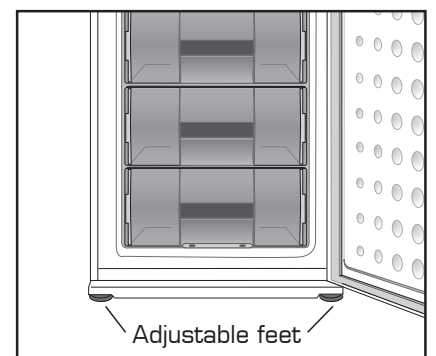

4 A special receptacle is supplied to store the mains plug during transit. The receptacle is fixed at the back of the cabinet on the side of the compressor. Gently remove the plug from the receptacle. Never pull the mains cord, you may damage the appliance. In case of transportation, ensure you locate the plug in the receptacle provided to avoid transit damage.

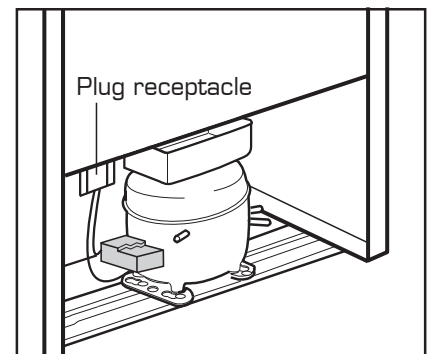

5 The space in the room where the appliance is installed must not be smaller than 10 cubic metres.

6 Fit the front grille supplied with your appliance as shown in the diagram.

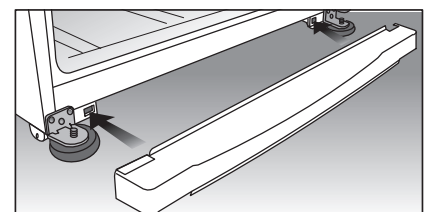

switching on for the first time

Before you switch on the appliance check:

- 1 Ensure all packaging have been removed.
 - 2 Ensure the appliance is kept for at least 4 hours in upright position.
 - 3 Ensure the feet have been adjusted for levelling.
 - 4 Ensure the interior is dry and air can circulate freely at the rear.
 - 5 Ensure the interior is clean as recommended under 'Care & cleaning'
 - 6 Insert the plug in to the wall socket and switch on the electricity supply.
 - The blue mains on 'power' light on the door trim will be on when the appliance is connected to the mains.
 - When the fridge door is open, the interior light in the fridge compartment will come on.
 - You may hear some noise as the compressor and the freezer fan start up. The liquid and gases may also give rise to noise, whether the compressor is running or not, which is quite normal.
- "Due to operation of the fan inside the frost free freezer compartment, overall noise level is slightly higher in comparison to non-frost free appliances. This is quite normal and is not a fault."**
- 7 Set the thermostat knob half way between Setting 1 and Setting 5.
 - 8 **Do not load with food immediately. Wait until the correct storage temperature has been reached.** We recommend that you check the temperature with an accurate thermometer (see section Temperature Control and Adjustment).
 - 9 When the freezer reaches the desired temperature the freezer fan will stop. When the freezer fan is on, the noise will be louder when the freezer door is opened.
 - The front edges of the cabinet may feel warm. This is normal. These areas are designed to be warm to avoid condensation.
 - 10 **Avoid spillage of food particularly small items like rice, peas, beans through the fan guard as they may cause the cooling system to block and therefore operate less efficiently.**
 - 11 "[FOR CDA752F model only] Before you use the water dispenser for the first time, clean the water tank interior with clean warm water."

temperature control & adjustment

Operating temperatures are controlled by the thermostat knob (see diagram) located on the ceiling of fridge compartment. Settings may be made from 1 to 5, 5 being the coldest position.

When the appliance is switched on for the first time, the thermostat should be adjusted so that after 24 hours, the average fridge temperature is no higher than +5 °C (+41 °F). We recommend you set the thermostat half way between the 1 and 5 setting and monitor to obtain the desired temperature i. e. towards 5 you will obtain a colder fridge and freezer temperature and vice versa. Some sections of the fridge may be cooler or warmer (such as the salad crisper and the top part of the cabinet) which is quite normal. The normal storage temperature of the freezer should be -18 °C (0 °F). Lower temperatures may be obtained by adjusting thermostat knob towards 5 position.

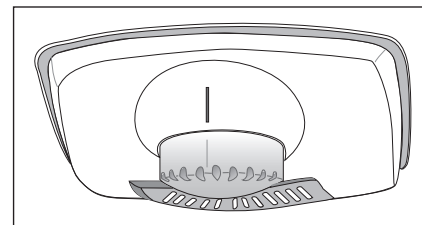

We recommend that you check the temperature with an accurate thermometer to ensure that storage compartments are kept to the desired temperature.

Remember you must take your reading very quickly since the thermometer temperature will rise very rapidly after you remove it from the freezer.

Please remember each time the door is opened cold air escapes and the internal temperature rises. Therefore never leave the door open and ensure it is closed immediately after food is put in or removed.

In case of a temporary ice build up in the fridge compartment, reduce the thermostat setting to 1, monitoring at the same time that the fridge temperature is maximum +5 degrees C [41 degrees F]. Once the ice build up disappears and the appliance starts auto defrosting again as normal, then you may increase the thermostat setting, if required.

When you set the thermostat knob to 0 [Zero] position, the appliance will be switched off completely.

repositioning the doors (see diagram on the opposite page)

- 1- Switch off the appliance at the socket outlet and pull out the mains plug.
- 2- Remove all loose items and fittings and food, if any, from inside the appliance and door racks.
- 3- Unscrew the bolts and remove the middle hinge while holding doors. **(1)**
- 4- Remove the fridge door from the top hinge. **(2)**
- 5- Remove the freezer door. **(3)**
- 6- Remove the plastic covers on the front top trim. **(4)**
- 7- Unscrew the bolts of the top hinge and remove top hinge. **(5)**
- 8- Reposition plugs on the opposite side. **(6)**
- 9- Remove the kick plate. **(7)**
- 10- Carefully tilt the appliance on its back. **(8)**
(You may need somebody to help you.)
- 11- Unscrew and remove the left hand side front feet. **(9)**
- 12- Unscrew and remove the bottom hinge. **(10)**
- 13- Remove the plastic cover and fit the tap which is in the Instruction Booklet bag to the other side. **(11)**
- 14- Unscrew and remove the middle hinge bushing from fridge door. **(12)**
- 15- Screw and fix the new middle hinge bushing which is supplied in Instruction Booklet bag to the other side. **(13)**
- 16- Reposition the hinge bushing and the tap on the freezer door. **(14)**
- 17- Unscrew and reposition the bottom hinge bushing. **(15)**
- 18- Unscrew bolt of the pin on the bottom hinge. Fit the pin to the other hole on the hinge and tighten the bolt on the new position. **(16)**
- 19- Fit the bottom hinge and other feet, and tighten the screws. **(17)**
- 20- Remove the plastic tap to the opposite side on the front bottom trim. **(18)**
- 21- Fit the front bottom trim to the bottom hinge and other feet. **(19)**
- 22- Rotate the top hinge 180°. Unscrew the hinge pin and re-tighten it to the opposite side. **(20)**
- 23- Fit the top hinge and tighten the bolts. **(21)**
- 24- Fit the plastic cover on the front top trim. **(22)**
- 25- Locate the freezer door to the bottom hinge and attach to the cabinet. **(23)**
- 26- Locate the middle hinge on the freezer door **(24)** and put the freezer door between the top and middle hinge carefully. **(25)**
- 27- Fit the middle hinge. Adjust the doors and tighten the bolts. **(26)**
- 28- Carefully stand your appliance (you may need somebody to help you) adjust the front feet.
- 29- Put back all, loose items and fittings.
- 30- Wait for at least 4 hours to allow the system to settle before switching on.
- 31- Once the correct storage temperatures have been reached in the appliance, put back all the food.

repositioning the doors

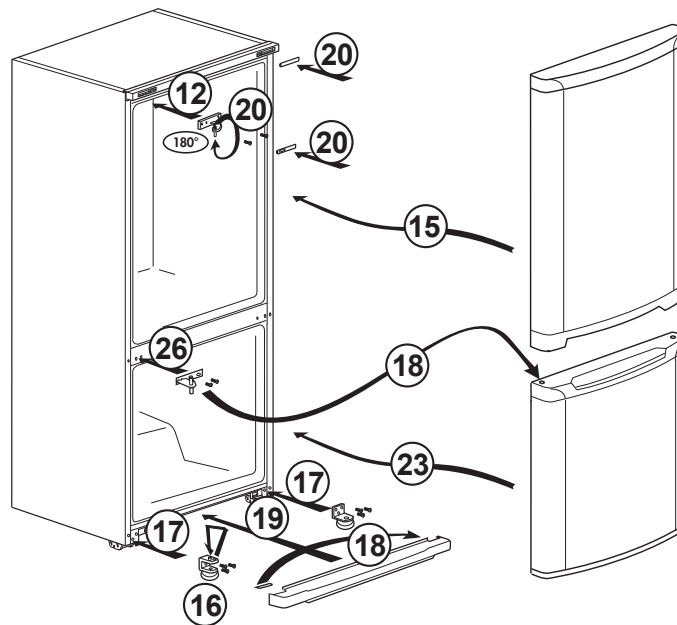
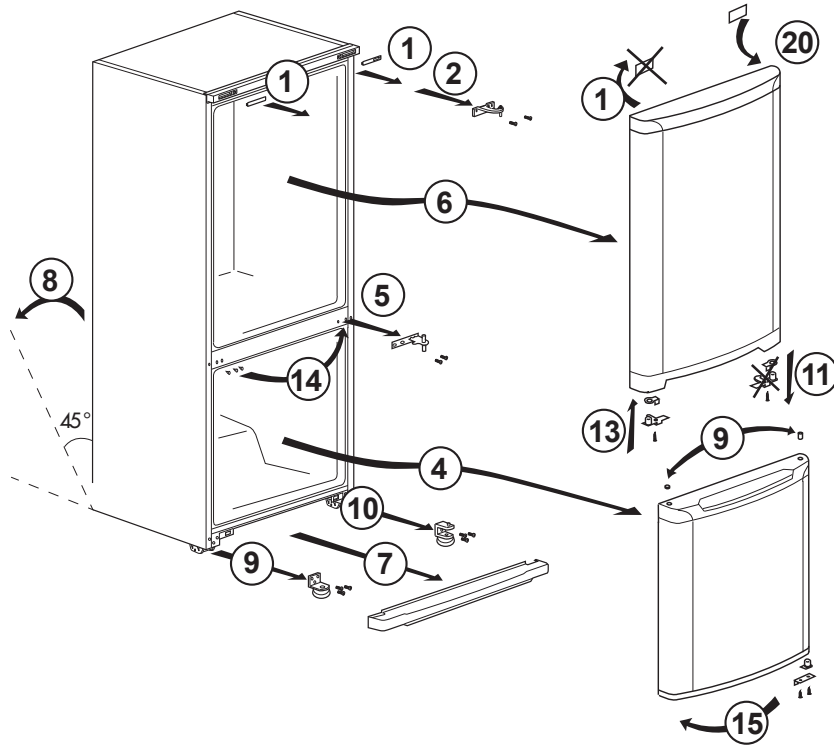

short term storage in the fridge compartment

Storing fresh food

Meat & poultry

- Wrap raw meat and poultry loosely in polythene bags or aluminium foil. This prevents drying.
- Wrap fish and offal in polythene bags and place on the lowest shelf.

Dairy

- Wrap cheese firstly in greaseproof paper and then in polythene bag excluding as much air as possible. For best results take out of the fridge compartment an hour before eating.
- Wrap bread well to keep it fresh.

Fruit & vegetables

- Take off any unusable leaves on vegetables and wipe off any soil.
- Leave lettuce, cabbage, parsley and cauliflower on the stem.
- Wrap pineapples, melons, cucumbers, tomatoes and similar produce in polythene bags as these types of produce may suffer damage if kept at very low temperatures.
- Wrap food, which has a strong odour, or can dry out, in polythene bags, aluminium foil, or place in an airtight container.

Fridge compartment storage advice

Fruit & vegetables

- Don't store bananas.
- Don't store melon - it can be chilled for short periods as long as it is wrapped to avoid it flavouring other food.
- Wrap food affected by temperatures near 0 °C (pineapples, cucumbers, tomatoes etc.) in polythene bags.

Meat & poultry

- Store raw meat and poultry below cooked food and dairy products.
- Do not allow raw meat to come into contact with cooked food to avoid contamination. For safety, only store raw meat for two to three days.

General

- Cooked dishes must be stored in airtight covered containers.
- Don't store cooked and fresh food together in the same container.
- Always allow hot food and beverages to cool first.
- Leftover canned food should not be stored in the can.
- Place chilled cooked food and similar food near the rear of the fridge where it is coldest.
- Keep food for as short a time as possible and adhere to 'best before' and 'use by' dates.
- Don't let defrosting food or food juices drip onto other food.
- Do not fill water tank with any liquid other than drinking water; beverages such as fruit juice, carbonated fizzy soda drinks, alcoholic drinks are not suitable for use with water dispenser. If such liquids are used, water dispenser will malfunction and may be damaged beyond repair. Guarantee does not cover such uses. Some chemical ingredients and additives in such drinks / beverages may also attack and damage water tank material.
- Only use clean pure drinking water.
- Capacity of water dispenser tank is 2.2 litres [3.8 pints], do not overfill.
- Push the water dispenser lever with a rigid cup. If you are using a plastic disposable cup, then push the lever with your fingers from behind the cup.
- Safety Locking knob is supplied for your convenience when filling the water tank and also to avoid small children tampering with the water dispenser.

fridge compartment

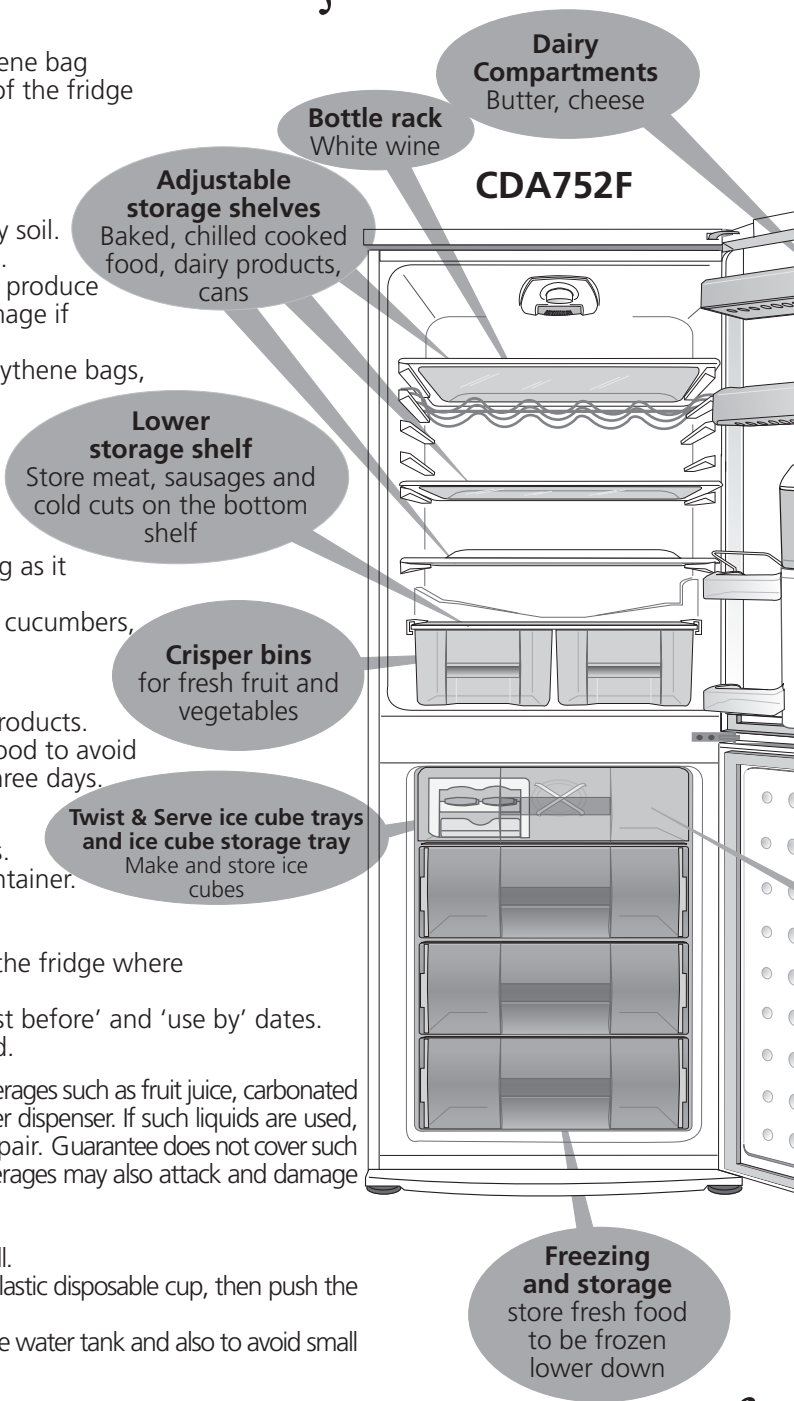

warnings!

The fan inside the freezer compartment circulates cold air. **Never insert any object through the guard. Do not allow children to play with the freezer fan.**

Never store products that contain inflammable propellant gas (eg dispensers, spray cans etc.) or explosive substances.

Do not allow children to play with the appliance or tamper with the controls.

Do not obstruct the freezer fan guard to ensure that you obtain the best possible performance from your appliance.

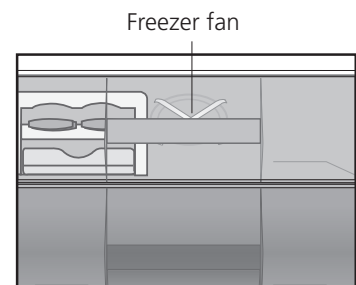

long term storage in the freezer compartment

partment

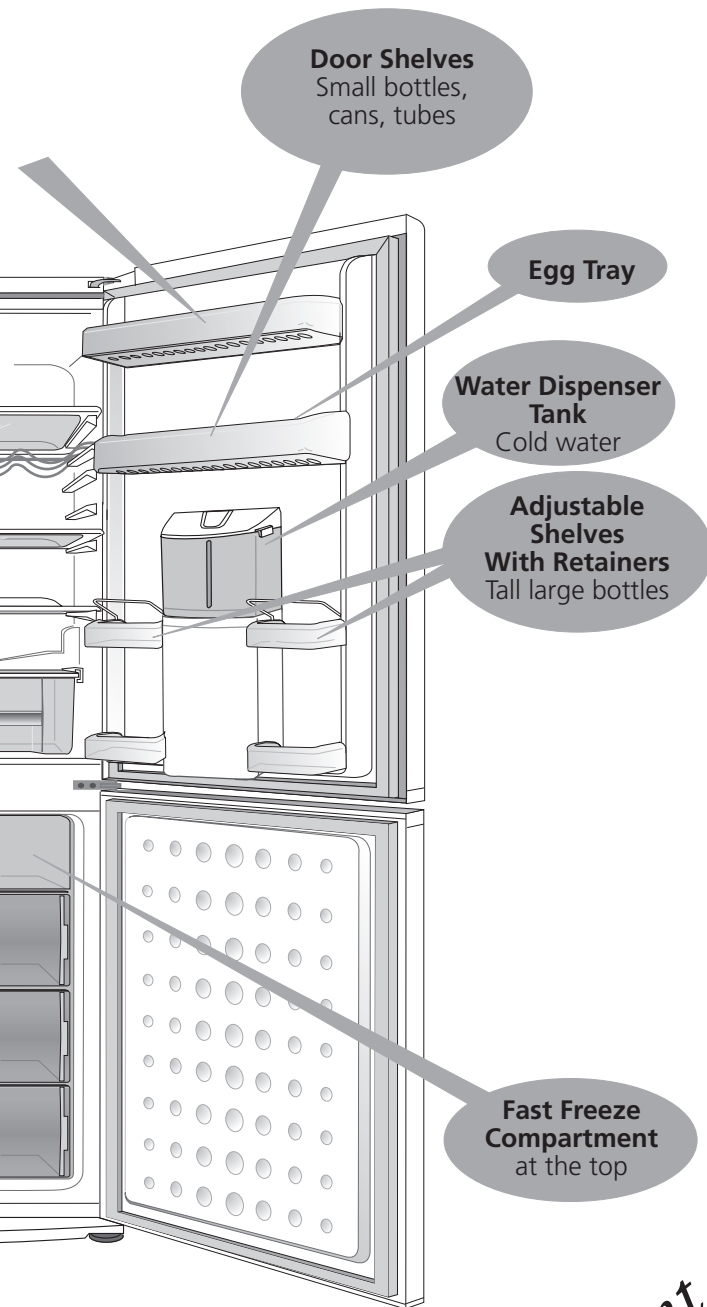

freezer compartment

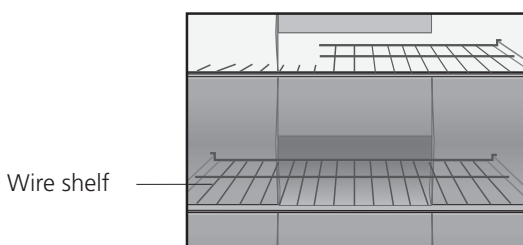

Storing pre-frozen food

- Take special care not to mix with fresh food.
- The recommendation for ******** storage as stated on the food packaging must always be followed.
- Pre-packed frozen food should be stored in accordance with the food manufacturer's instructions for a ******** frozen food storage compartment.
- To ensure that the high quality achieved by the food manufacturer and retailer is maintained:
 - 1 Wrap packets when you buy them.
 - 2 Put packets in the freezer as quickly as possible after purchase.
 - 3 Ensure that contents are labelled and dated.
 - 4 Do not exceed 'use by' and 'best before' dates.

Freezing fresh food

- Take special care not to mix with already frozen food.
- Always choose high quality fresh food and be sure it is thoroughly clean.

Amounts

- Prepare fresh food in small portions to ensure rapid freezing. Do not freeze too large a quantity at any one time. The quality is best preserved when the food is frozen right through to the core as quickly as possible.
- Do not exceed the freezing capacity which in a 24 hour period is 6 kg (13 lbs).
- When freezing the maximum amount, turn the thermostat knob to maximum 5.
- When freezing average amounts, the thermostat knob can be kept at medium position. i.e. 2 kg (5lbs)
- When freezing small quantities, up to 1/2 kg (1 lb), the thermostat knob will not need adjusting.

Preparation

- Wrap food in aluminium foil or freezer quality polythene bags.
- Wrap fish and offal in polythene bags.
- Wrap food which has a strong odour or can dry out, in polythene bags, aluminium foil, or place in airtight containers.
- Make sure all air is excluded from foil wrapping or bags.

Freezer compartment storage info/advice

- Do not leave frozen food at room temperature to thaw; the best way to defrost food is to put it in the fridge to thaw slowly. Make sure you avoid defrosting food or food juices drip onto other food.
- The freezer compartment is ******** rated and suitable for the freezing and storage of pre-frozen food.
- Don't freeze filled bottles or sealed cans containing fizzy (carbonated) drinks as they may burst.
- Check contents of the freezer every so often.
- Don't close the freezer door before placing the fast freeze compartment cover in its place.
- Don't try to keep frozen food which has thawed, it should be eaten within 24 hours or cooked and re-frozen.
- If there is a power failure do not open the door. Frozen food should not be affected if the failure lasts for less than 18 hours. If the failure is longer, then the food should be checked and either eaten immediately or cooked and then re-frozen.
- Placing warm food into the freezer compartment causes the compressor to operate continuously until the food is frozen solid. This can temporarily lead to excessive cooling of the refrigeration compartment.
- "The wire shelf between the two full depth plastic drawers can be removed temporarily if you want to store a turkey. After you remove the drawers, pull out the wire shelf as shown in the diagram. Reverse the sequence of operations when you re-fit the wire shelf back in to its position. Make sure you fit it properly otherwise operation of drawers will be affected."

Serving

- Don't remove items from the freezer with wet hands.
- Don't give children ice cream and water ices direct from the freezer. The low temperature may cause 'freezer burns' on lips.
- Defrost food from the freezer in the fridge compartment.
- Products such as flavoured water ices should not be consumed too cold.

CDA751F (Model without Water Dispenser)

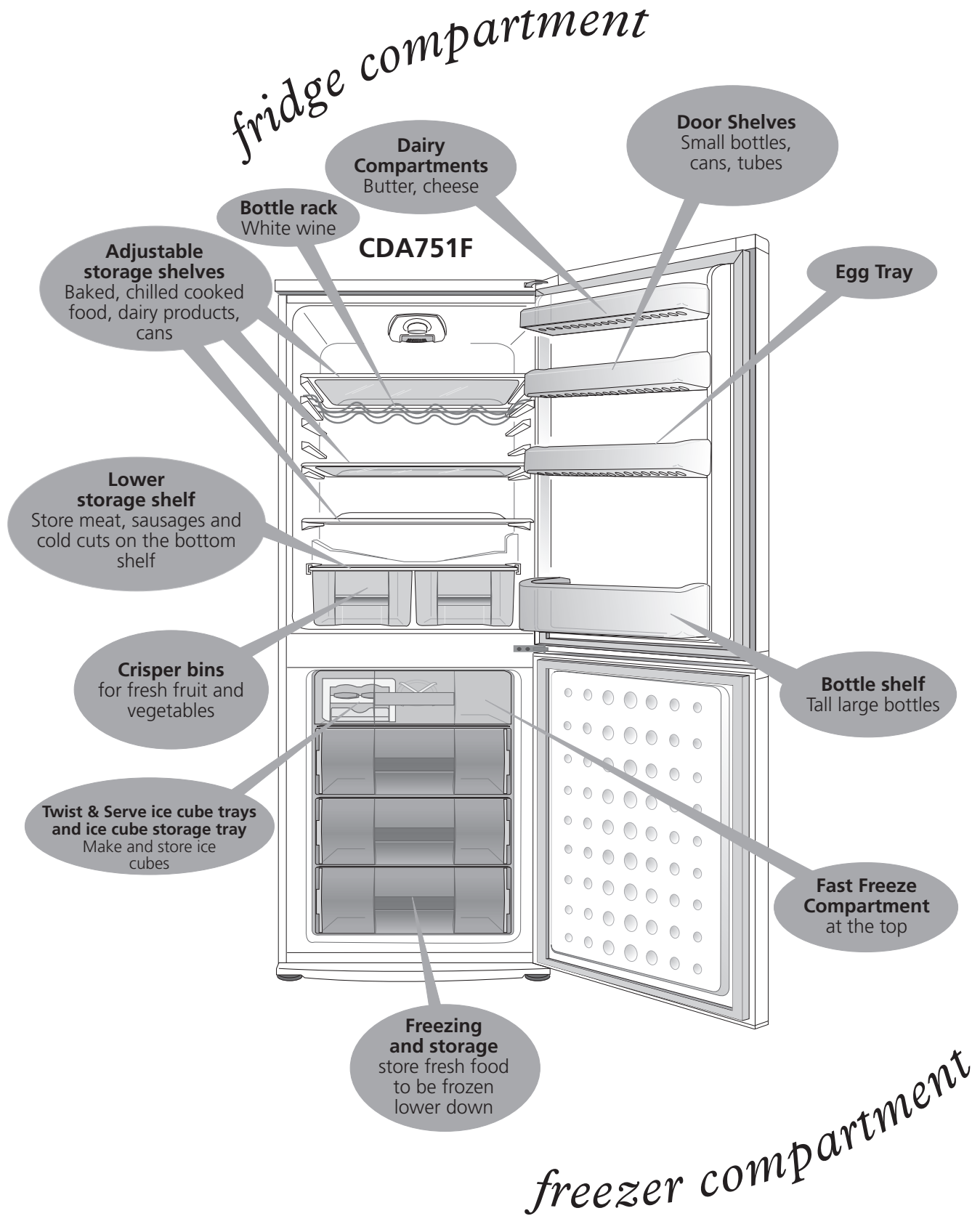

Water dispenser (CDA752F ONLY)

Water dispenser is a very useful feature to obtain chilled water without opening the door of your fridge. Since you do not have to open the door of your fridge frequently, you also save on electricity.

Using the water dispenser

Push in the lever of the water dispenser with your glass. By releasing the lever, you cut off the dispensing. When operating the water dispenser, maximum flow is achieved by fully depressing the lever. Please note, how much water flows from the dispenser depends on how far you depress the lever. As the level of water in your cup / glass rises, gently reduce the amount of pressure on the lever to avoid overflow. If you depress the lever a small amount, then water will trickle; this is perfectly normal and is not a fault.

Filling in the water tank of water dispenser

Open the cap of the water tank as illustrated in the figure. Fill in with pure and clean drinking water. Close the cap.

To avoid accidental water dispensing, we recommend you to lock the water dispenser. [See Page 16]

Caution!

- Do not fill water tank with any liquid other than drinking water; beverages such as fruit juice, carbonated fizzy soda drinks, alcoholic drinks are not suitable for use with water dispenser. If such liquids are used, the water dispenser will malfunction and may be damaged beyond repair. The guarantee does not cover such uses. Some chemical ingredients and additives in such drinks / beverages may also attack and damage water tank material.

- Only use clean pure drinking water.
- Capacity of water dispenser tank is 2.2 litres [3.8 pints], do not overfill.
- Push the water dispenser lever with a rigid cup. If you are using a plastic disposable cup, then push the lever with your fingers from behind the cup.
- Safety Lock is supplied for your convenience when filling the water tank and also to avoid small children tampering with the water dispenser. [See Page 16]

Cleaning the water tank

Remove the water tank, open the latches on both sides and detach the top cover mechanism from the water tank. Clean the water tank with warm clean water, reinstall the top cover mechanism and fasten the latches.

When installing the water tank, make sure that hooks behind it fits securely into the hangers on the door. Make sure that parts removed during cleaning (if any) are installed correctly into their original locations. Otherwise, water may leak.

Important:

Water tank and components of water dispenser are not dishwasher-proof.

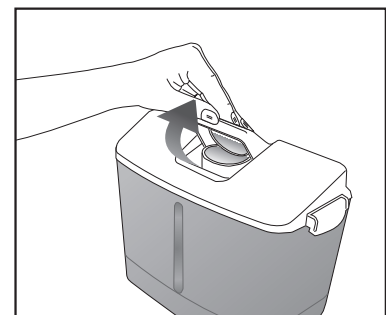
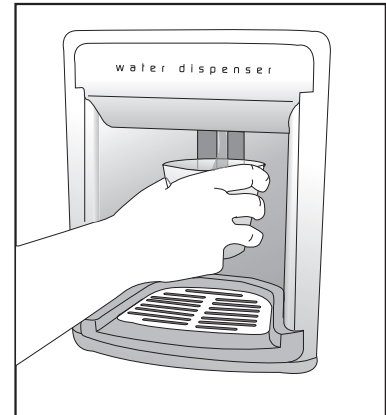

Water Tank Capacity \approx 2.2 Litres

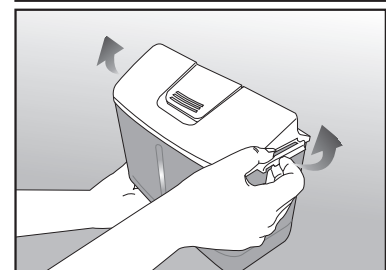
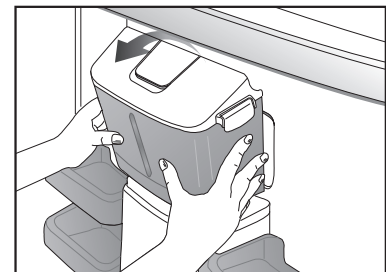
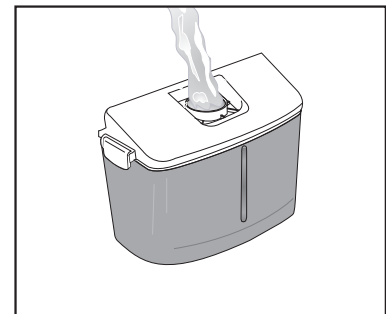

how to use the accessories



Safety lock for Water Dispenser

You may use the lock in order to avoid small children tampering with the water dispenser. To do this, slide the locking latch from left to right as illustrated in the figure. You must slide the latch back to left position in order to use the water dispenser.

To avoid accidental water dispensing, we recommend you to lock the water dispenser.

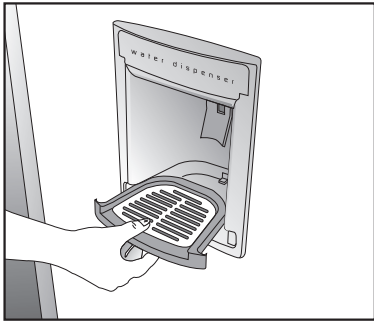

Water tray

Water that drips while using the water dispenser accumulates in the drip tray. Remove the drip tray by pulling it towards yourself and empty it from time to time.

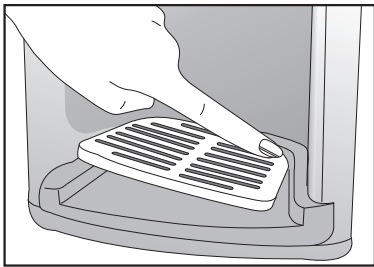

Remove the plastic drainer part as shown in the diagram by pressing down on the edge.

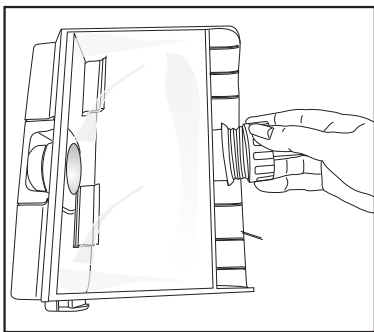

Remove the water valve from the water tank as shown in the diagram. When re-fitting, make sure the O-shaped seal is in place.

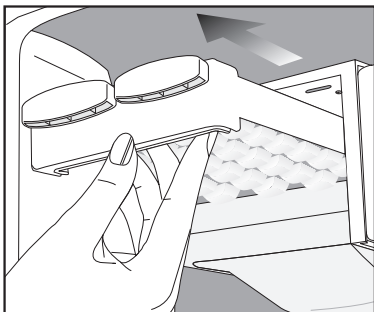

Twist and serve ice cube trays and ice cube storage tray

Fill ice cube trays 2/3 with water and place them in the freezer. To dispense the ice cubes, twist the tray as shown. Store ice cubes in the tray underneath.

Warning! Do not fill ice cube storage tray with water.

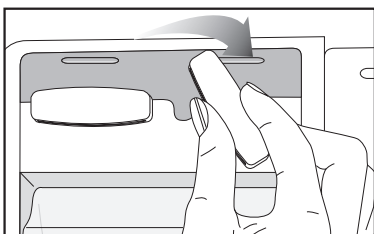

Fridge compartment

The fridge compartment defrosts automatically. The defrosting water runs to the drain tray at the back of the appliance via the collection channel and drain tube.

During defrosting, water droplets may form at the back of the fridge compartment where the concealed evaporator is located. Some droplets may remain on the liner and re-freeze when defrosting is completed, this is normal. Do not use pointed or sharp edged objects, such as knives or forks, to remove the droplets which have frozen.

If at any time the defrost water does not drain from the collection channel, check to ensure that no food particles have blocked the drain channel. The drain tube can be cleared by pushing the special plastic plunger provided down the drain tube. If the frost layer reaches about $\frac{1}{4}$ " (7mm), reduce the setting (ie from 4 to 2) to restart automatic defrosting.

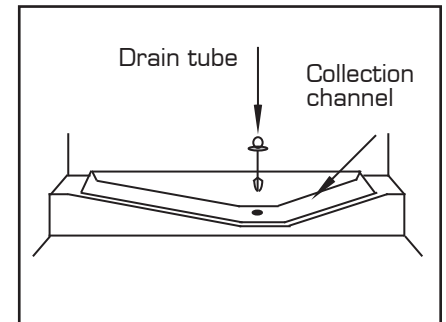

Freezer compartment

The freezer compartment operation is frost free and does not need defrosting.

energy saving tips

- Ensure your appliance is installed in a well-ventilated area. Do not put your appliance in a cold room where the temperature is likely to go below +5°C (41°F) during night time and/or especially in winter.
- Ensure the time between buying chilled/frozen food and placing them in your appliance is kept to a minimum, particularly in summer. We recommend you use a cool bag or a special carrier bag to carry frozen food.
- Don't leave the door(s) of your appliance open longer than necessary and ensure they are closed properly after each opening.
- Don't leave the door open for a long periods as this will make the appliance more costly to run and cause excessive ice formation.
- Don't put hot food into the appliance. Let it cool down first.

care & cleaning

Care

If the appliance is not going to be used for a long period of time, switch it off, remove all food, clean it and leave the door ajar.

Don't use pointed sharp edged objects such as knives and forks to remove ice.

Cleaning

Clean your appliance regularly.

Never use any sharp abrasive instrument, soap, household cleaner, detergent or wax polish for cleaning.

1 Switch off the appliance at the socket outlet and pull out the mains plug.

2 Clean the outside with lukewarm water and wipe dry.

3 Clean the interior with a damp cloth wrung out in a solution of one teaspoon of bicarbonate of soda to one pint of water and wipe dry.

- Make sure that no water enters internal light housing.
- Any dust that gathers on the condenser, which is located at the back of appliance, should be removed once a year with a vacuum cleaner.

Important

- Care must be taken when cleaning the appliance to avoid touching the bottom of the condenser metal support/pipework at the back of the appliance as you might injure your fingers and hands or damage your product.
- Check door seals regularly to ensure they are clean and free from food particles.

Removing covers, trays, flaps and doors

- To remove a door tray, remove all the contents and then simply push the door tray upwards from the base.
- To remove a freezer basket, pull it as far as possible, then tilt it upwards and then pull it out completely.
- To remove the freezer flap door, first open the door by about 2" and then pull it off. Make sure that the flap is in place before closing the freezer door.

Drain tray

Make sure that the special plastic container (drain tray) at the back of the appliance which collects defrost water is clean at all times. If you want to remove the tray to clean it follow the instructions below:

- Switch off at the socket outlet and pull out the mains plug.
- Push the lug down with the tip of a screw driver & pull out with a jerk movement.
- Clean the drain tray and wipe it dry.
- Reassemble reversing the sequence and operations.

STAINLESS STEEL DOOR CLEANING INSTRUCTIONS [ONLY VALID FOR STAINLESS STEEL MODELS WHICH HAVE "X" SUFFIX IN THE MODEL NUMBER]

Stainless steel surfaces of your appliance require special cleaning methods. In order to eliminate marks on doors and to keep your appliance doors clean, we recommend you the following to clean and wipe the stainless steel surfaces of doors:

- 1.** You can purchase special cleaning materials suitable for stainless steel surfaces of kitchen appliances from your local store. Follow the instructions supplied by the manufacturer of such cleaning materials.
- 2.** You can purchase a special micro-fibre cleaning cloth pack called "E-cloth" from your local electrical or hardware store, which is suitable to clean and wipe stainless steel surfaces of kitchen appliances without the need to use any chemicals or other cleaning materials. You just need warm water. You need to follow the instructions supplied inside the packaging of E-cloth.

Never attempt to clean, wipe or treat the stainless steel and other surfaces of your appliance with unsuitable material, do not clean or wipe handles and plastic surfaces using stainless steel cleaning materials, otherwise, your guarantee will be void.

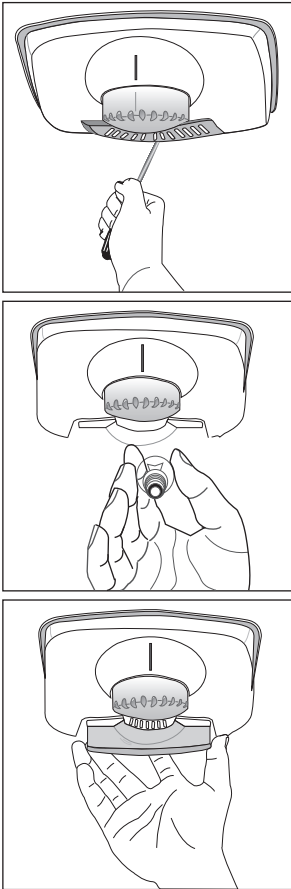

Should the light fail to work, proceed as follows.

- 1. Switch off at the socket outlet and pull out the mains plug.**
 - You may find it useful to remove shelves for easy access.
- 2.** Use a flat tipped screwdriver to remove the light diffuser cover by inserting the blade in each of the two recesses to prise off each side.
- 3.** First check that the bulb hasn't worked loose by ensuring it is screwed securely in the holder. Replace the plug and switch on. If the bulb works, replace the light cover by inserting the rear lug and pushing up to locate the front two lugs.
- 4.** If the light still fails to work, switch off at the socket outlet and pull out the mains plug. Replace the bulb with a new 15 watt (max) screw cap (SES) bulb.
- 5.** Carefully dispose of the burnt-out light bulb immediately. Replacement light bulb can easily be obtained from a good local electrical or DIY store.

trouble shooting

If the appliance does not operate when switched on, check:

- 1** The plug is inserted properly in the socket and that the power supply is on.
 - 2** The power supply to the socket by plugging in another appliance.
 - 3** The fuse has blown/circuit breaker has tripped/main distribution switch has been turned off.
 - 4** The temperature control has been set correctly.
 - 5** If you have changed the fitted moulded plug, ensure the new plug is wired correctly.
- If the appliance is still not operating after the above checks, please refer to the section on how to obtain service.
 - **Please ensure that the above checks have been made as a charge will be made if no fault is found.**

disposal

If you are discarding an old refrigerator with a lock or latch fitted to the door, disable the lock/latch; ensure that it is left in a safe condition to prevent the entrapment of young children.

Do not dispose of any appliance on a fire. Your appliance contains non-CFC/HFC substances in the insulation and in the cooling system, which are potentially flammable if exposed to fire. We suggest you contact your local authority for disposal information and facilities available.

guarantee

Your new Beko product is guaranteed against the cost of breakdown repairs for twelve months from the date of the original purchase.

What is covered?

- Repairs necessary as a result of faulty materials, defective components or manufacturing defect.
- The cost of functional replacement parts, but excluding consumable items.
- The labour costs of a Beko approved repairer to carry out the repair.

What is not covered?

- Transit, delivery or accidental damage or misuse and abuse.
- Cabinet or appearance parts, including knobs, flaps, handles or container lids.
- Accessories or consumable items including but not limited to, ice trays, scrapers, cutlery baskets, filters and light bulbs.
- Repairs required as a result of unauthorized repair or inexperienced installation that fails to meet the requirements contained in the user instruction book.
- Repairs to products used on commercial or non-residential household premises.
- Loss of frozen food in freezers or fridge/freezers. (Food loss insurance is often included within your household contents insurance policy, or may be available separately from your retailer).

Important notes.

- Your Beko product is designed and built for domestic household use only.
- The guarantee will be void if the product is installed or used in commercial or non-residential domestic household premises.
- The product must be correctly installed, located and operated in accordance with the instructions contained in the User Instructions Booklet provided.
- Professional installation by a qualified Electrical Domestic Appliance Installer is recommended for all Washing Machines, Dishwashers and Electric Cookers.
- Gas Cookers must only be installed by a CORGI (or BORD GAIS) registered Gas Installer.
- The guarantee is given only within the boundaries of the United Kingdom and the Republic of Ireland.
- The guarantee is applicable only to new products and is not transferable if the product is resold.
- Beko disclaims any liability for incidental or consequential damages. The guarantee does not in anyway diminish your statutory or legal rights.

Please keep your purchase receipt or other proof of purchase in a safe place; you will need to have it should the product require attention under guarantee.

You should also complete the details below; it will help us assist you when requesting service. (The model number is printed on the Instruction Booklet and the serial number is printed on the Rating Label affixed to the appliance)

Model No: Serial No: Retailer: Date of purchase:

For service under guarantee simply telephone the appropriate number below

UK Mainland & Northern Ireland

Fridges & Freezers	0870 241 0638
Electric Cookers	0870 241 1320
Gas & Dual Fuel Cookers	0870 241 1321
Washing Machines & Dishwashers	0870 241 0357

Republic of Ireland

All Refrigeration, All Cookers	01 862 3411
Washing Machines & Dishwashers	

Before requesting service please check the trouble-shooting guide in the Operating Instructions as a charge may be levied where no fault is found even though your product may still be under guarantee.

Service once the manufacturers guarantee has expired.

If you have purchased an extended guarantee please refer to the instructions contained within the extended guarantee agreement document. Otherwise please call the appropriate number above where service can be obtained at a charge.

Should you experience any difficulty in obtaining service please contact the Beko Customer Help-Line. Tel: 0870 774 1050 e-mail: service@beko.co.uk

	<p>This product bears the selective sorting symbol for waste electrical and electronic equipment (WEEE). This means that this product must be handled pursuant to European Directive 2002/96/EC in order to be recycled or dismantled to minimize its impact on the environment. For further information, please contact your local or regional authorities.</p> <p>Electronic products not included in the selective sorting process are potentially dangerous for the environment and human health due to the presence of hazardous substances.</p>
---	---